

fig. 1-1

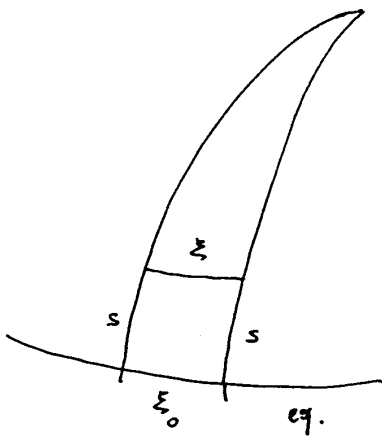

fig. 1-2

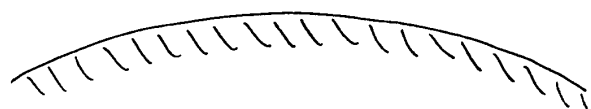
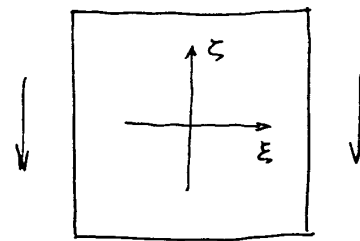

fig. 1-3

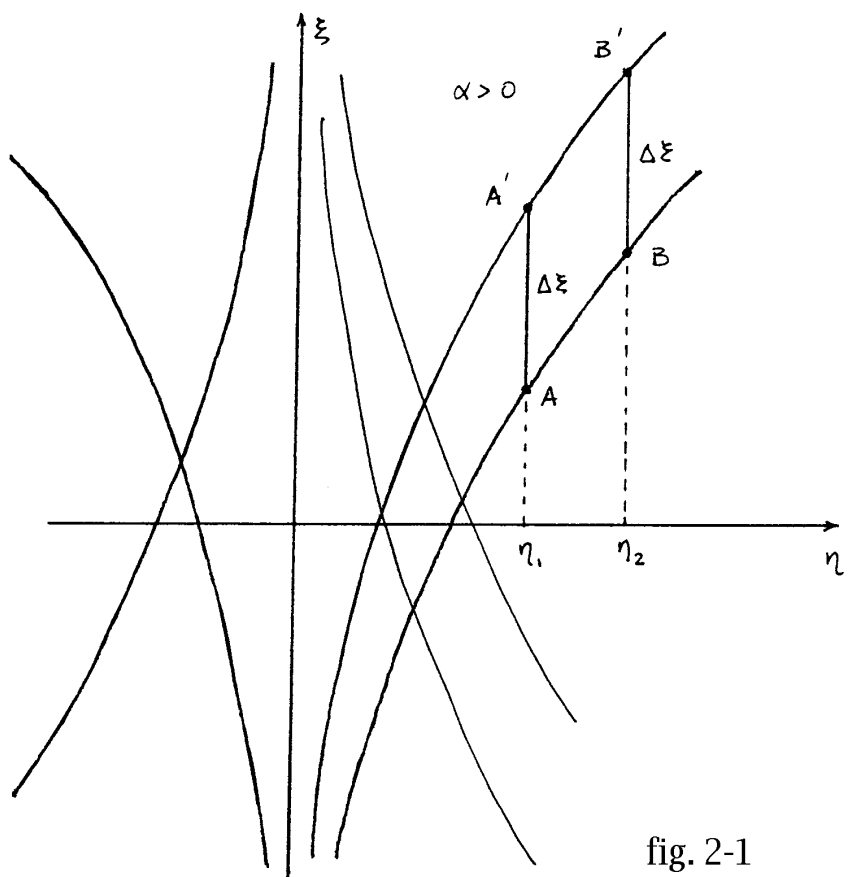

fig. 2-1

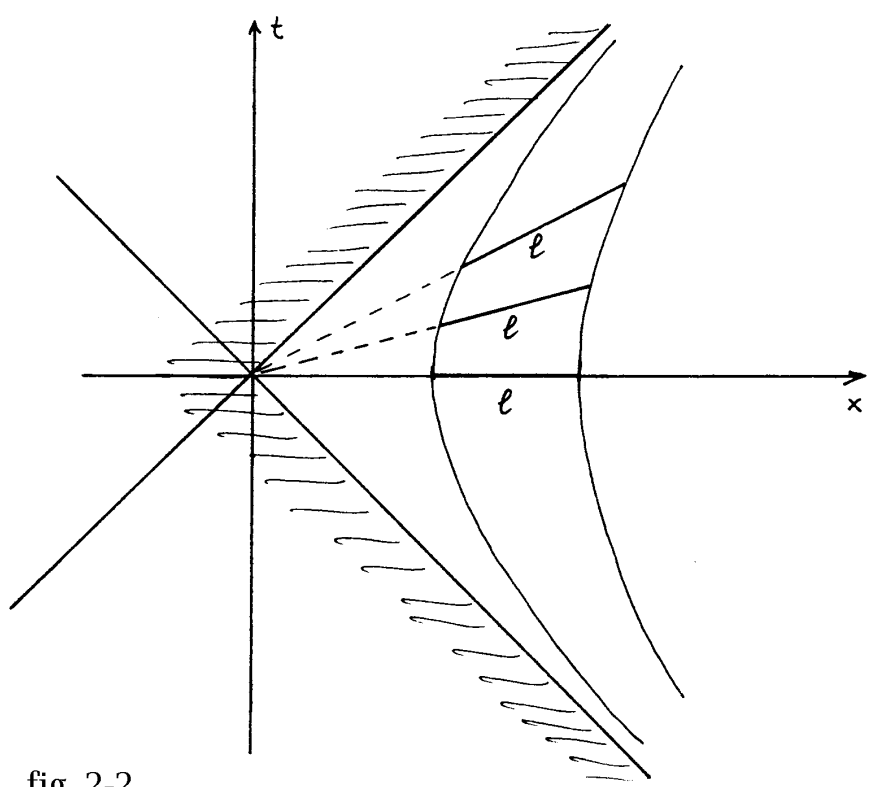

fig. 2-2

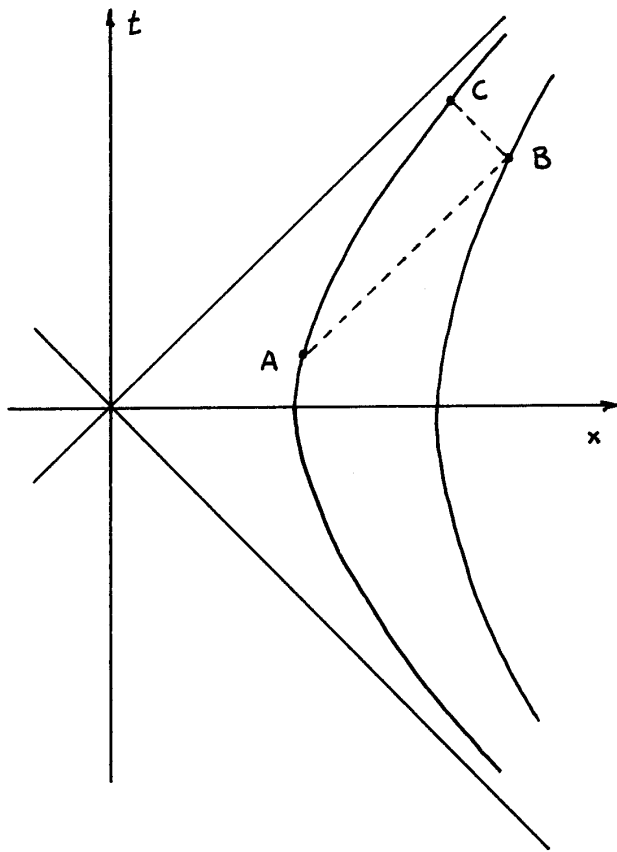

fig. 2-3

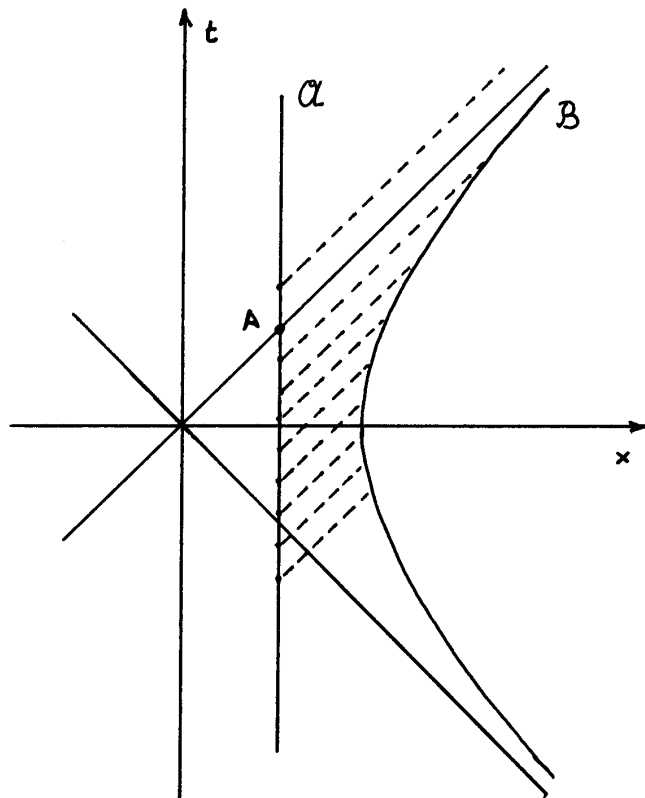

fig. 2-4

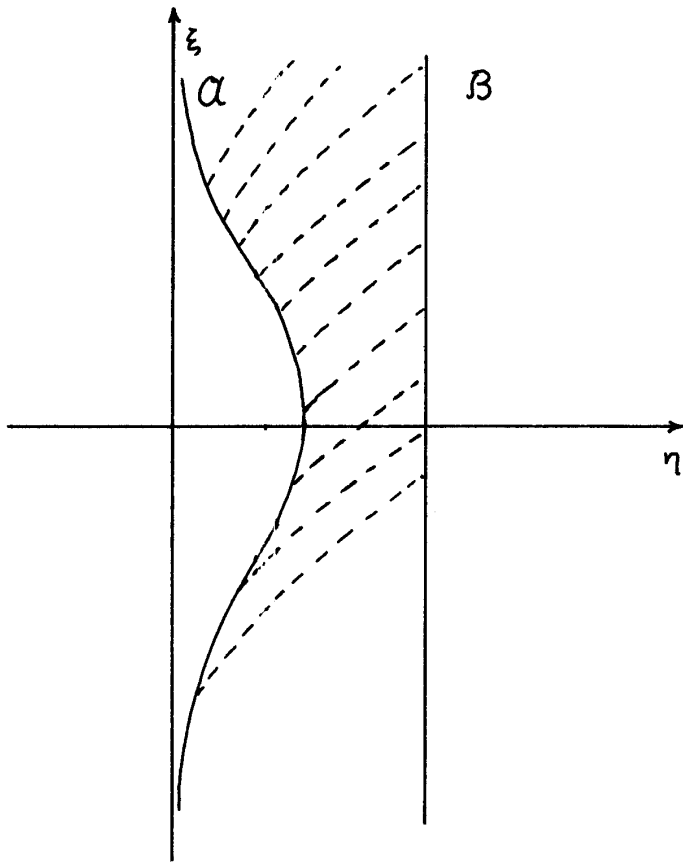

fig. 2-5

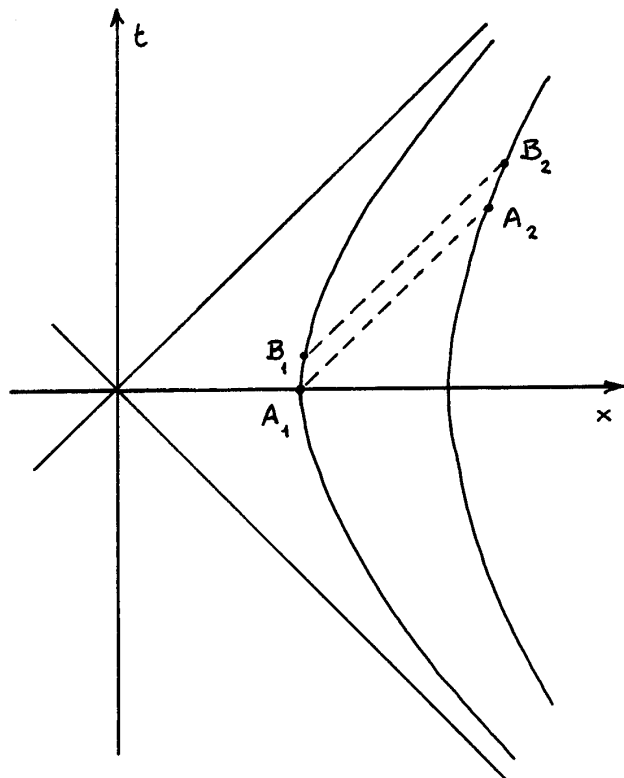

fig. 2-6

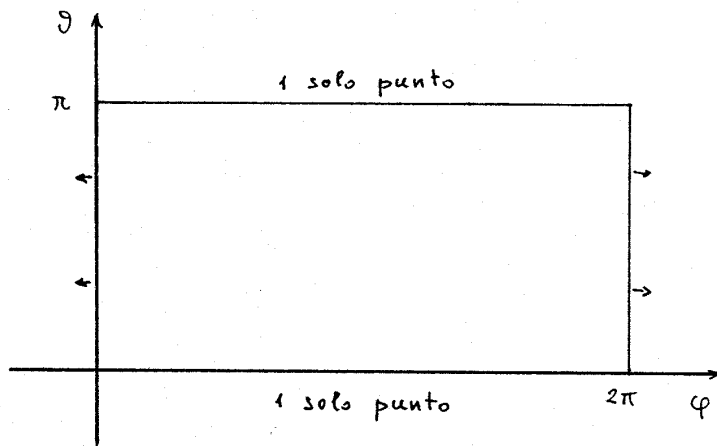

fig. 4-1

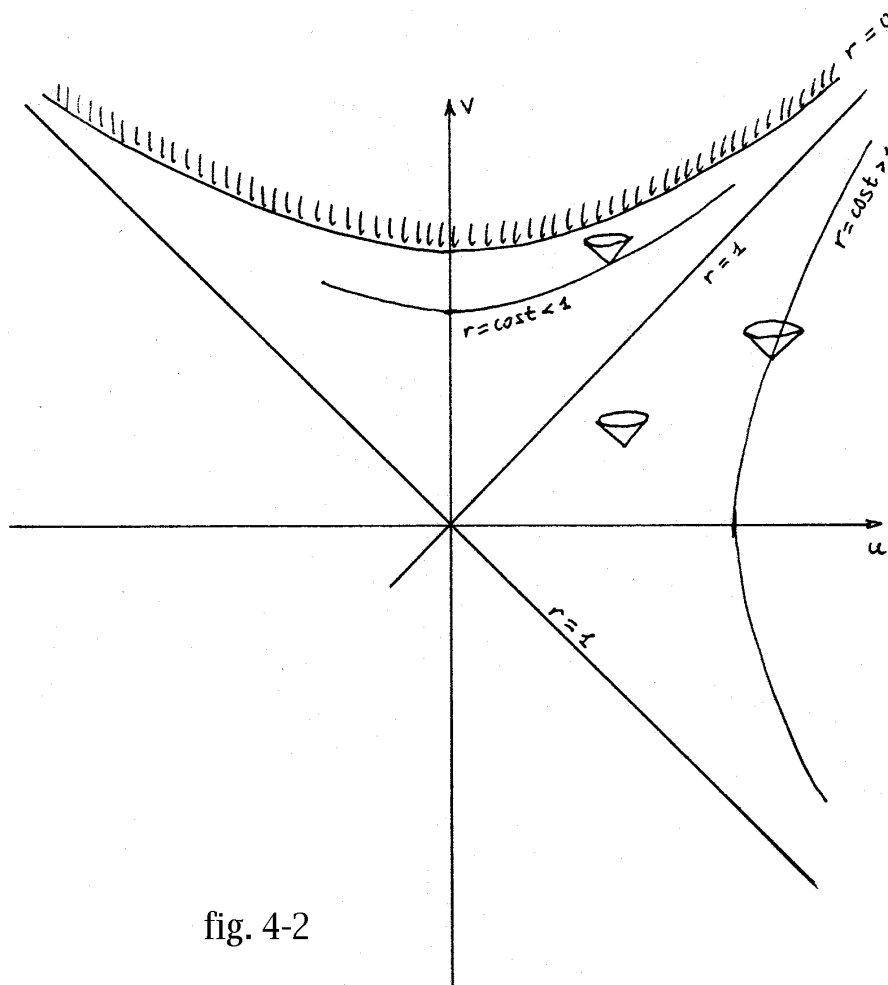

fig. 4-2

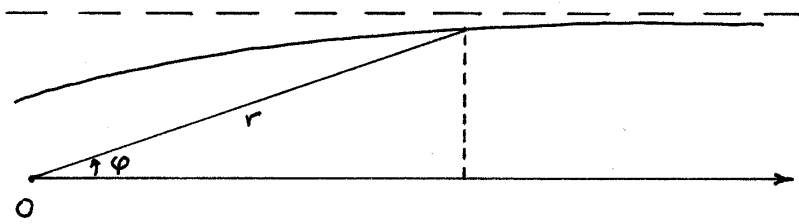

fig. 5-1

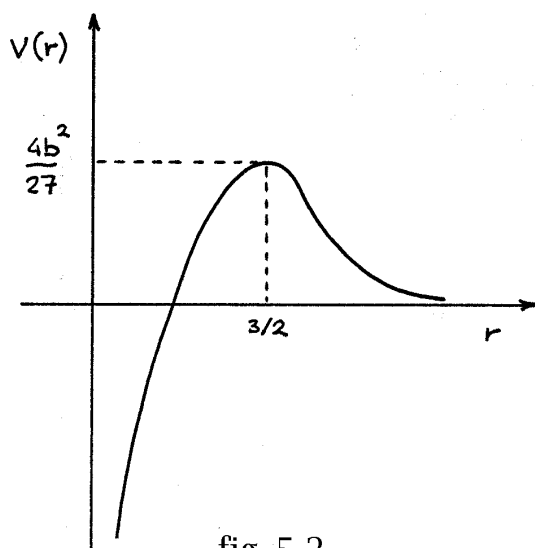

fig. 5-2

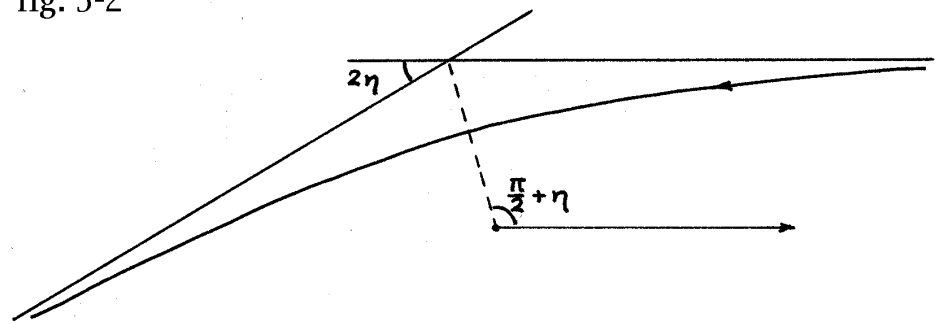

fig. 6-1

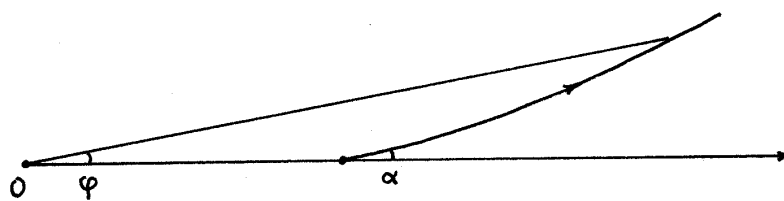

fig. 6-2

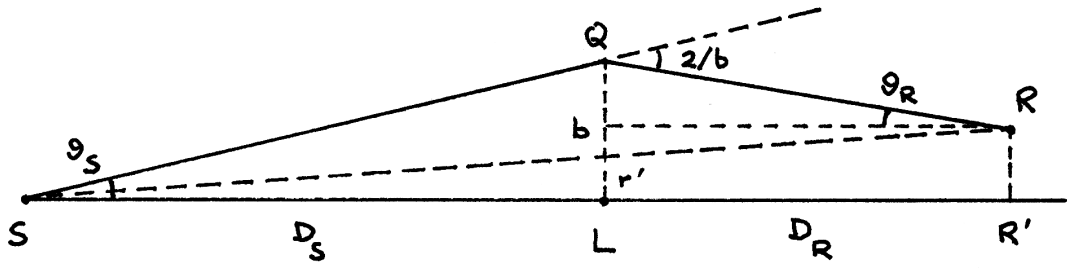

fig. 7-1

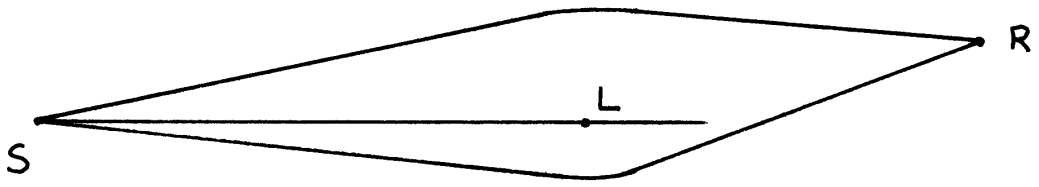

fig. 7-2

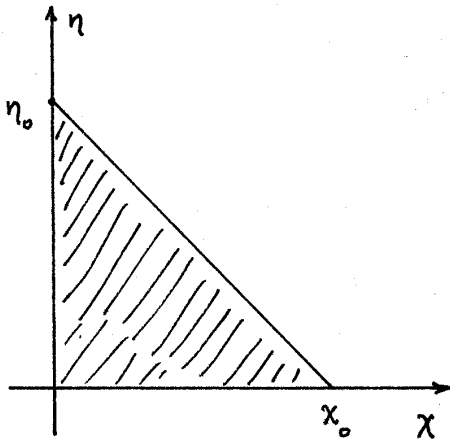

fig. 8-1

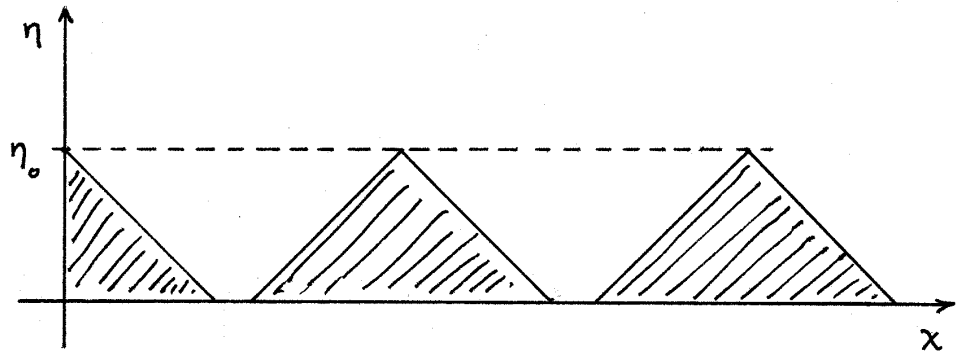

fig. 8-2

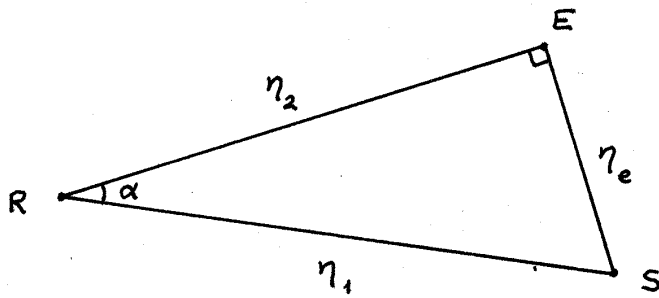

fig. 8-3



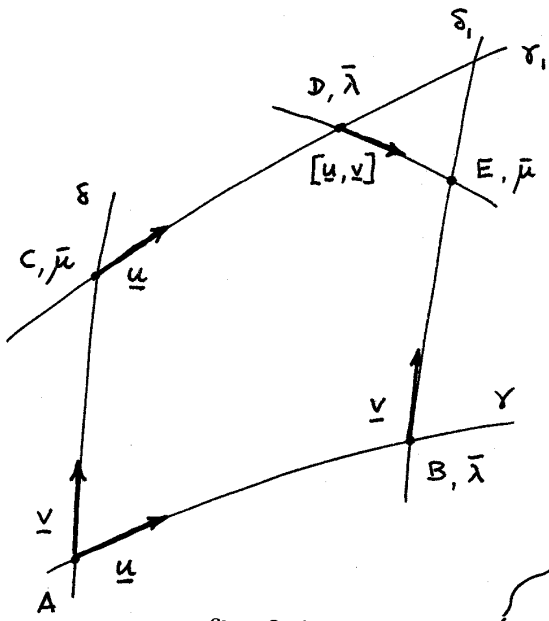

fig. 9-1

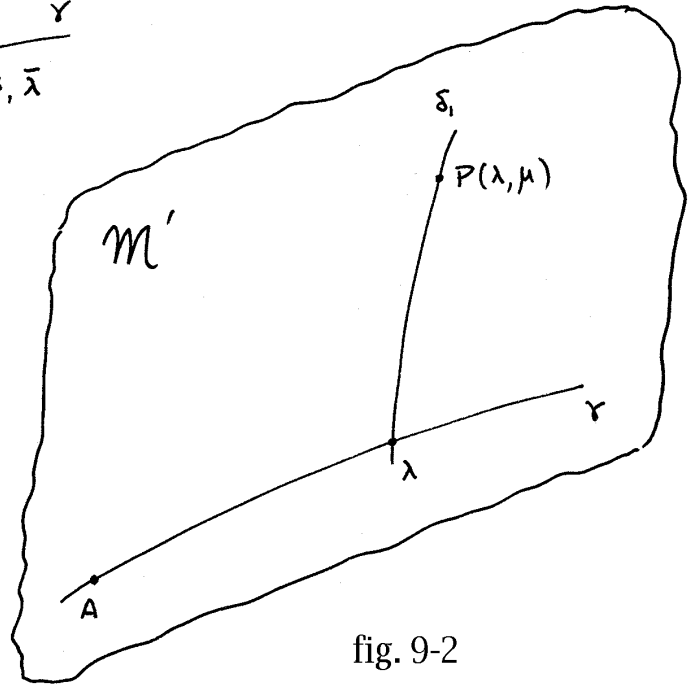

fig. 9-2

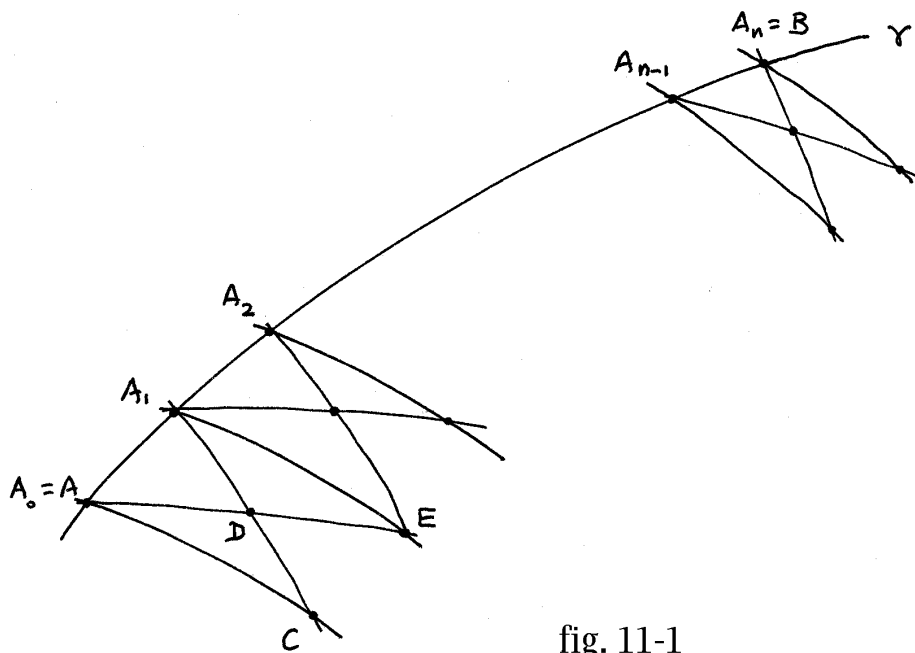

fig. 11-1

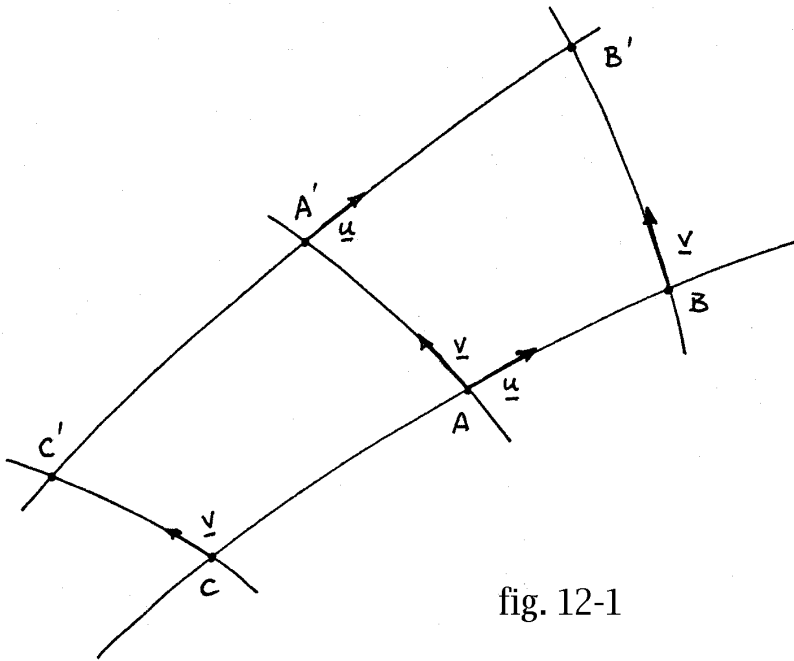

fig. 12-1

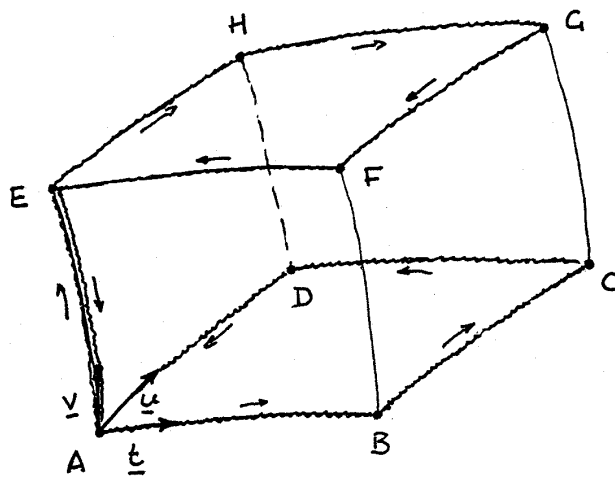

fig. 12-2

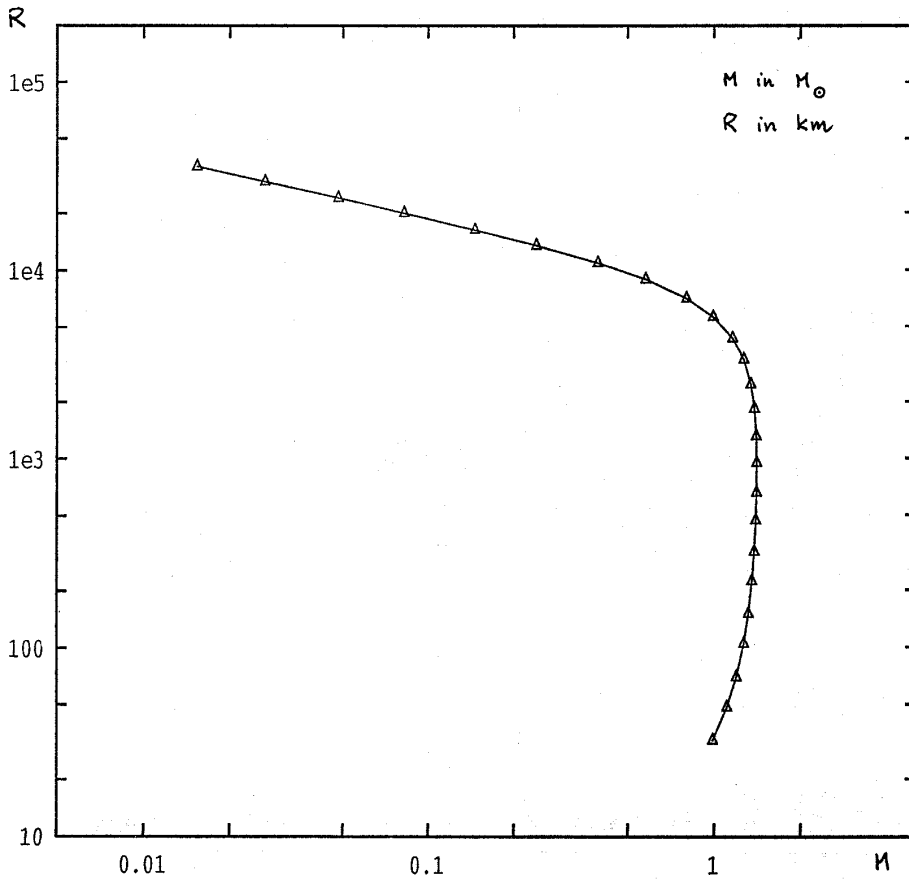

fig. 21-1

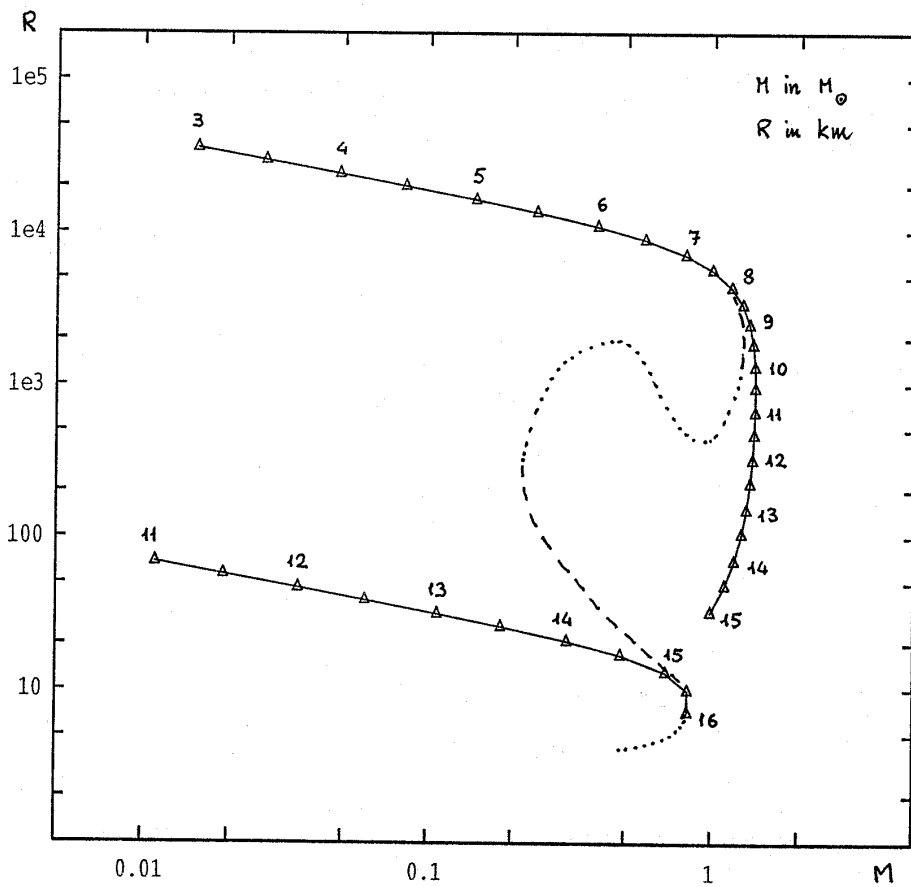

fig. 21-2

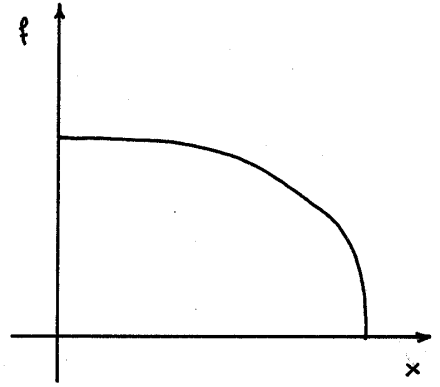

fig. 22-1

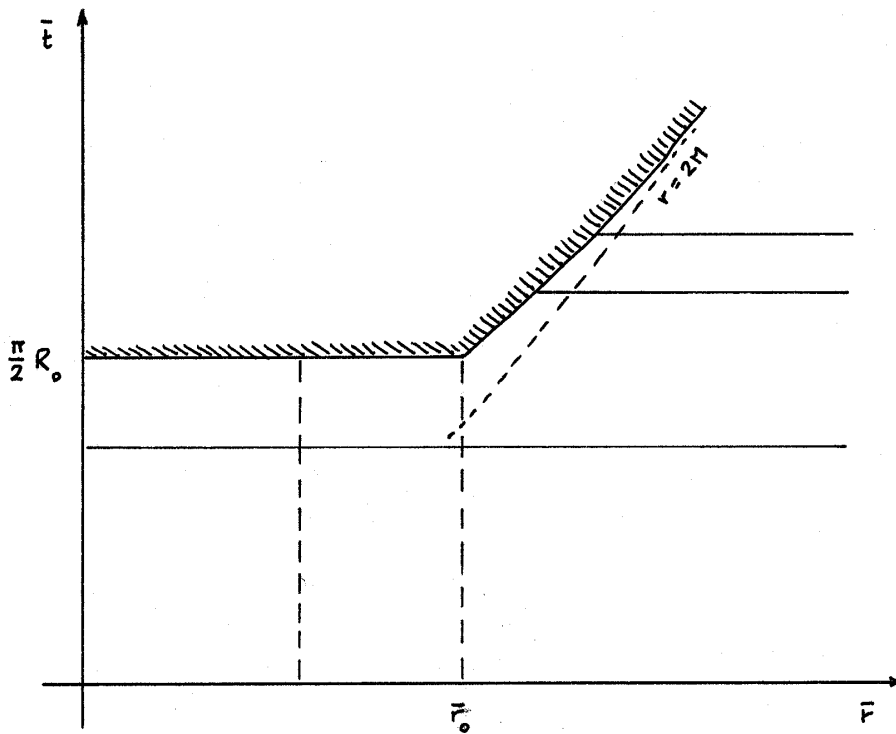

fig. 22-2

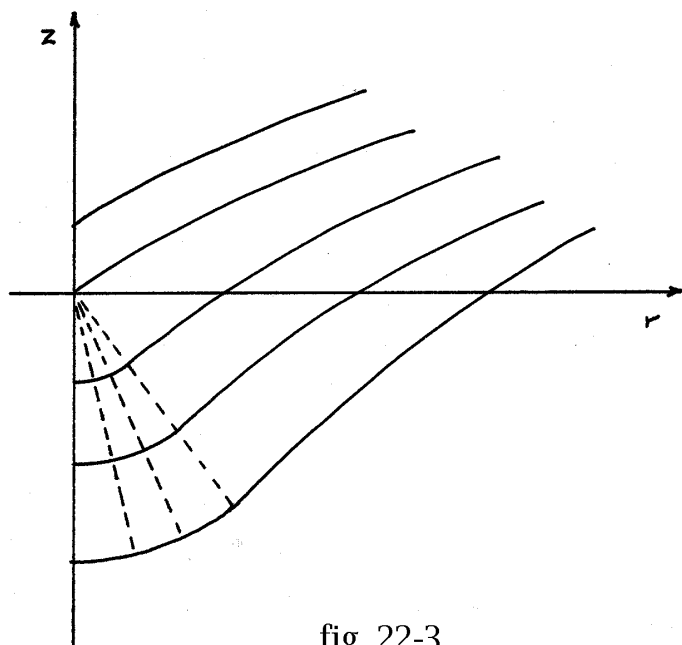

fig. 22-3

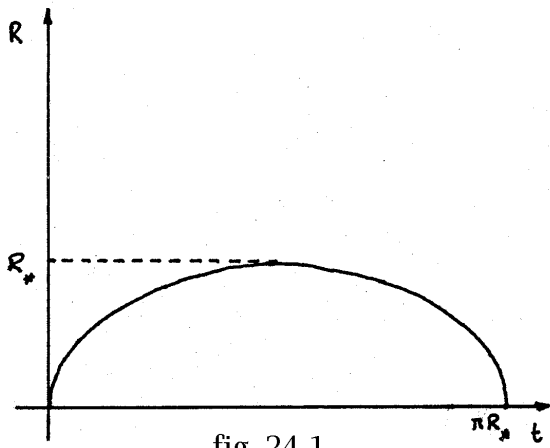

fig. 24-1

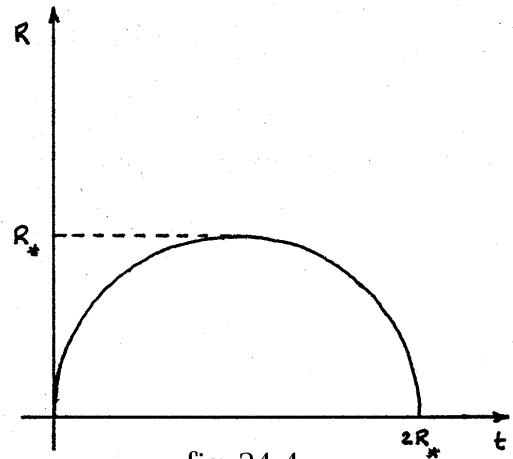

fig. 24-4

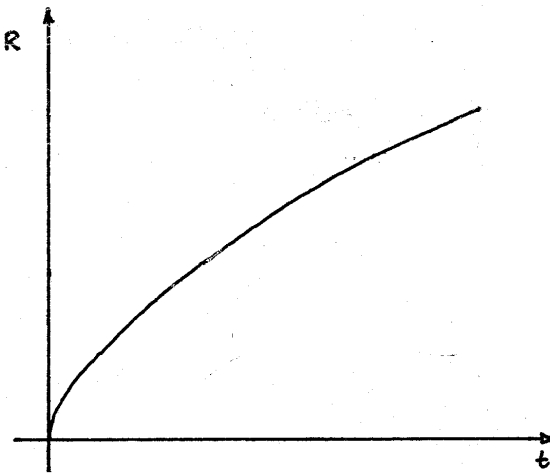

fig. 24-2

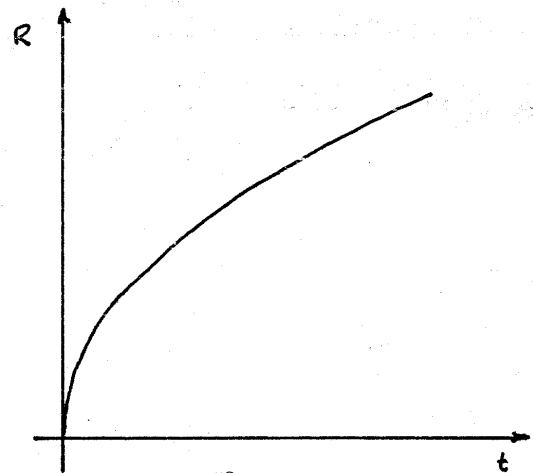

fig. 24-5

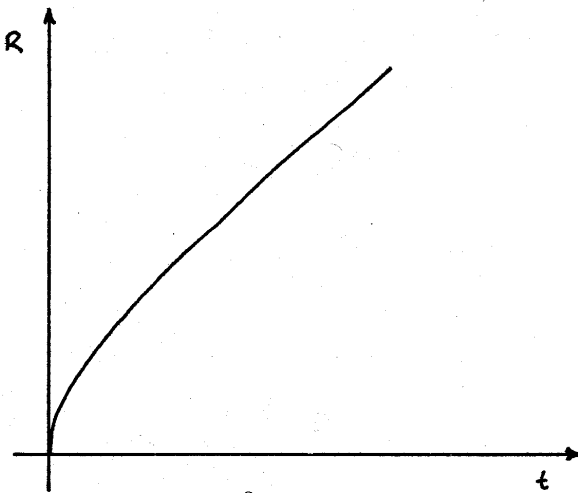

fig. 24-3

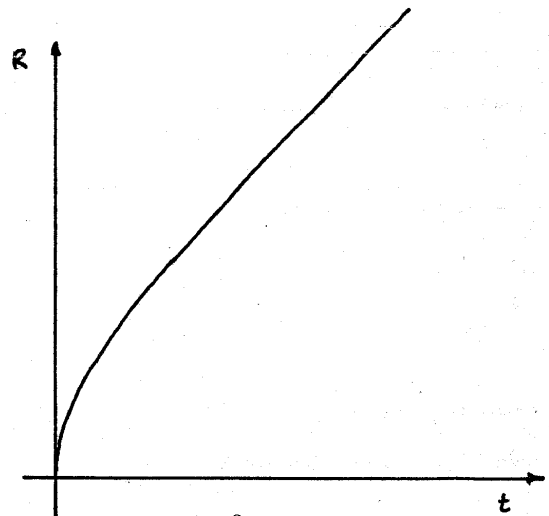

fig. 24-6